

Weighing Platform



PBA436 Platform

Hygienic Design

IP65 Water-Resistant

Durable Construction



Durable, Easy-to-Clean Design
Dry or Light Hose-Down Applications

METTLER TOLEDO

Affordable Weighing Platforms

Built for Mild Wash-Down Environments

The PBA436 stainless steel platform is a robust, durable and economical solution for a wide range of weighing tasks with light hose-down requirements. This platform series is a perfect fit in many industrial applications where there is a need for durability, streamlined cleaning and protection against splashing, humidity and condensation.



Accuracy Protection

Optimally placed and independently adjusted overload stops ensure the best possible protection against load cell damage to give you confidence in your scale's accuracy over time.



High Durability

The electropolished, fully stainless steel construction is designed to withstand harsh environments to ensure equipment reliability and longevity.

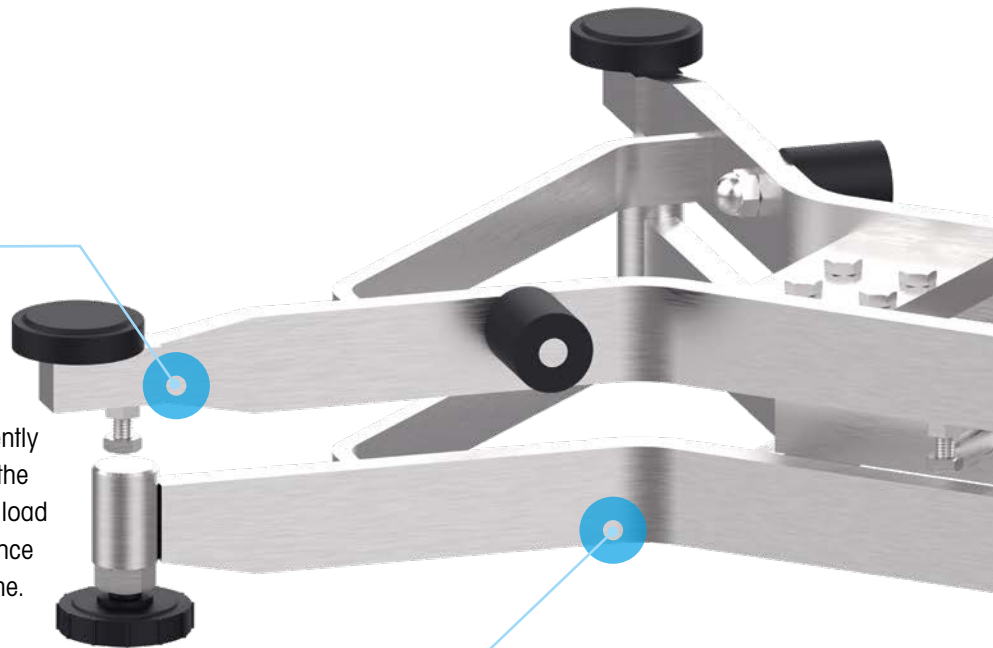

“ Learn more about the PBA436 . ”
Visit the page: www.mt.com/PBA436



Hygienic Design

The open, sturdy frame design provides easy access to all parts of the construction to improve cleaning efficiency and eliminate contamination risk.



Precise Leveling

The fixed mounting plate offers a leveling bubble to help operators determine the optimal positioning for accurate weighing results, and easily adjustable feet allow for quick and precise leveling execution.



Optional Hygienic Kit

To further reduce the risk of contamination, this platform series offers an optional hygienic kit, containing leveling feet and overload stops without open threads so water and residue have no place to collect and hide.

Technical Specifications - Metric

Standard Configurations

Metric (kg/m)

Model	Platform size	Maximum capacity							Cable length	
		3 kg	6 kg	15 kg	30 kg	60 kg	150 kg	300 kg		
PBA436-QA	228 × 228 [mm]	3 kg	6 kg						1.5 m	
PBA436-A	240 × 300 [mm]	3 kg	6 kg	15 kg					1.5 m	
PBA436-QB	305 × 305 [mm]			15 kg	30 kg	60 kg			2 m	
PBA436-BB	300 × 400 [mm]				30 kg	60 kg			2 m	
PBA436-B	400 × 500 [mm]				30 kg	60 kg	150 kg		3 m	
PBA436-BC	500 × 650 [mm]					60 kg	150 kg	300 kg	3 m	
PBA436-CC	600 × 800 [mm]					60 kg	150 kg	300 kg	600 kg	3 m

Weights and Measures - Legal for Trade Data

OIML (International Organization of Legal Metrology)

OIML certification provides confidence that a weighing device complies with the OIML R76 regulation, which establishes the metrological characteristics required for weighing instruments and specifies methods and equipment for checking their conformity.

OIML / Metric (kg/m)		Maximum capacity							
		3 kg	6 kg	15 kg	30 kg	60 kg	150 kg	300 kg	600 kg
Approved resolution Class III single range - 1×3,000e									
Approved readability (e min.)	[g]	1	2	5	10	20	50	100	200
Minimum capacity	[g]	20	40	100	200	400	1,000	2,000	4,000
Approved resolution Class III multi-range - 2×3,000e									
Approved readability (Max1/e1)	[kg/g]	n/a	3/1	6/2	15/5	30/10	60/20	150/50	300/100
Approved readability (Max2/e2)	[kg/g]	n/a	6/2	15/5	30/10	60/20	150/50	300/100	600/200
Minimum capacity	[g]	n/a	20	40	100	200	400	1,000	2,000
Weigh & Measure OIML general thresholds									
Preload range	[%]	18% of Maximum capacity							
Zero setting range	[%]	2% of Maximum capacity							
Taring range	[kg]	Subtractive from 0 to Maximum capacity							
Temperature range	[°C]	-10°C...+40°C							

Weighing - Performance Data

Performance data or typical values are determined in production with no wind drafts and no vibration. Typical values represent the statistical mean value of all measured devices.

Metric (kg/m)		Maximum capacity							
		3 kg	6 kg	15 kg	30 kg	60 kg	150 kg	300 kg	600 kg
Readabilities at max. resolution (~15,000d/2x3,000e)									
Recommended readability (min.)	[g]	0.2	0.5	1	2	5	10	20	50
Minimum Weight @ 1%	[g]	16.4	41	82	164	410	820	1640	4100
Typical values									
Repeatability sd (at full load)	[g]	0.10	0.20	0.40	0.80	1.80	2.20	5.60	6.20
Error of indication typ. (at half load)	[g]	0.16	0.50	1.60	1.40	4.20	4.60	13.90	21.10
Error of indication typ (at full load)	[g]	0.10	0.50	0.70	2.10	4.90	6.40	19.20	26.80

Max. Preload for non-approved platforms without Weighing Platter

Metric (kg/m)		Maximum capacity							Weight Weighing Platter (kg)	
		3 kg	6 kg	15 kg	30 kg	60 kg	150 kg	300 kg		600 kg
QA (228 x 228 mm)	[kg]	6.9	3.9							0.95
A (240 x 300 mm)	[kg]	6.5	3.5	5.5						1.23
QB (305 x 305 mm)	[kg]			5.3	18.3	38.3				1.51
BB (300 x 400 mm)	[kg]				17.9	37.9				1.86
B (400 x 500 mm)	[kg]				66.5	36.5	46.5			2.85
BC (500 x 650 mm)	[kg]					32.9	92.9	192.9		5.8
CC (600 x 800 mm)	[kg]					30.6	90.6	190.6	138.4	11 / 14.1*

*600 kg Model

Glossary

Weighing terms	Simple definition
Readability	The smallest difference in mass that can be read on a weighing instrument. For instruments with a digital display, the readability is equal to the division value or actual scale interval of the display. Recommended readability (min.) is what is prescribed by the manufacturer; whereas, approved readability is prescribed (or mandated) by weights and measures authorities.
Resolution	Smallest difference between displayed indications that can be meaningfully distinguished - this is a non-technical expression for the number of scale intervals. Sometimes confused with readability.
Minimum capacity	The lower range of a scale that should not be used, this range is mandated by weights and measures intended to eliminate excessive relative weighing errors. In industry, it is recommended to use minimum weight instead because it is considered a more accurate method that considers the customer's production tolerance.
Repeatability	Ability of a weighing instrument to provide results that agree one with the other when the same load is deposited several times in a practically identical way on the load receptor under reasonably constant test conditions. Repeatability is expressed as a standard deviation.
Error of Indication at full load / half load	The difference between the weight indicated on the display and the actual test weight (full load / half load) placed on the scale. The value represents the combined error of non-linearity, sensitivity offset and repeatability. Note: Sometimes this is wrongly referred to as sensitivity error, or span error.
Minimum weight	Smallest (sample) weight required for a weighment to achieve a desired weighing tolerance. Weighing below the minimum weight threshold results in errors because the sample weight is too small to achieve the defined process tolerance.



We offer global and local partnership, no matter where you do business.

Whether you are a multinational business or a systems integrator serving customers worldwide, our globally approved weighing platforms enable you to standardize your weighing solutions to minimize procurement and engineering hours and deliver a reliable value to your customers or production facilities worldwide. Our comprehensive consulting and extensive weighing portfolio are available to help you simplify your job.

**For more technical information
see the user manual.**



Technical Specifications

Platform Dimensions

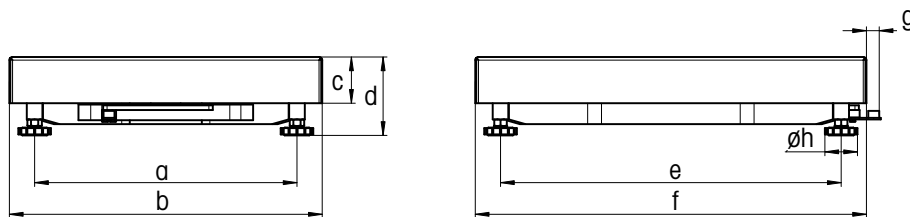

Dimensions of PBA436 in mm

Dimensions		a	b	c	dmin*	e	f	g	h
QA	mm	163	228	56	85.6	163	228	21	42
A	mm	175	240	56	85.6	235	300	21	42
QB	mm	240	305	57	96.6	253	305	18	42
BB	mm	235	300	57	96.6	335	400	18	42
B	mm	335	400	59	100.1	435	500	18	42
BC	mm	437	500	73	110.8	584	650	17	42
CC	mm	503	600	85	132	724	800	18	42

*Non-hygienic kits. For hygienic kits, the height of the platform increases 12 mm.

Dimensions of PBA436 in inch

Dimensions		a	b	c	dmin*	e	f	g	h
QA	inch	6.42	8.98	2.2	3.37	6.42	8.98	0.83	1.65
A	inch	6.89	9.45	2.2	3.37	9.25	11.81	0.83	1.65
QB	inch	9.45	12.01	2.24	3.8	9.96	12.01	0.71	1.65
BB	inch	9.25	11.81	2.24	3.8	13.19	15.75	0.71	1.65
B	inch	13.19	15.75	2.32	3.94	17.13	19.69	0.71	1.65
BC	inch	17.2	19.69	2.87	4.36	22.99	25.59	0.67	1.65
CC	inch	19.8	23.62	3.35	5.2	28.5	31.5	0.71	1.65

*Non-hygienic kits. For hygienic kits, the height of the platform increases 0.47 inch.

Construction per platform size



A = 240 × 300 mm / 9.5" × 11.8"
QA = 228 × 228 mm / 9" × 9"



BB = 300 × 400mm / 11.8" × 15.7"
QB = 305 × 305mm / 12" × 12"
B = 400 × 500mm / 15.7" × 19.7"







BC = 500 × 650mm / 19.7" x 25.6"
CC = 600 × 800mm / 23.6" x 31.5"

General Specifications

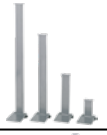
Ingress protection	IP65	
Material	Platform frame: stainless steel (AISI 304)	
	Load plate: stainless steel (AISI 304)	
Surface	Load plate: Ra ≤ 1.6um	
Load cell	Aluminium, potted	
Compliance	Metrology	OIML Class III, NTEP Class III
	EMC	10 V/m
Scale interface	Analog	
Operating temperature	Compensated	-10°C to +40°C / 14°F to 104°F)
	Operation	-10°C...+50°C / 14°F...+122°F
Suitable Indicators	Safe Area: all analog Mettler-Toledo indicators	

Accessories

Article #	Designation	Description	Picture
72229393	Column open 120mm/4.7"	Fits for all platform size	
72198702	Column open 330mm/13"	Fits for all platform size	
72198703	Column open 660mm/26"	Fits for all platform size	
72198704	Column open 900mm/35.4"	Fits for all platform size larger than A-size	
72225939	Stainless steel cart BC	Fits for BC-size platform	
72225940	Stainless steel cart CC	Fits for CC-size platform	
30253326	Roller track 400 x 500 mm / 15.7" x 19.7" stainless steel	Fits for B-size platform. Roll to short side of platform	
30253328	Roller track 500 x 650 mm / 19.7" x 25.6" stainless steel	Fits for BC-size platform. Roll to short side of platform	
30253330	Roller track 600 x 800 mm / 23.6" x 31.5" stainless steel	Fits for CC-size platform. Roll to short side of platform	
30253327	Roller track 400 x 500 mm / 15.7" x 19.7" stainless steel	Fits for B-size platform. Roll to long side of platform	
30253329	Roller track 500 x 650 mm / 19.7" x 25.6" stainless steel	Fits for BC-size platform. Roll to long side of platform	
30253331	Roller track 600 x 800 mm / 23.6" x 31.5" stainless steel	Fits for CC-size platform. Roll to long side of platform	
22021062	Front mount bracket	Fit for ICS4_9 front mount	
30676769	AISI 316 stainless steel platter 240 x 300 mm /9.5" x 11.8"	Fits for A-size platform	
30676770	AISI 316 stainless steel platter 300 x 400 mm /11.8" x 15.7"	Fits for BB-size platform	
30676771	AISI 316 stainless steel platter 400 x 500 mm /15.7" x 19.7"	Fits for B-size platform	
30676772	AISI 316 stainless steel platter 228 x 228 mm /9" x 9"	Fits for QA-size platform	
30676773	AISI 316 stainless steel platter 305 x 305 mm /12" x 12"	Fits for QB-size platform	
30676774	AISI 316 stainless steel platter 500 x 650 mm /19.7" x 25.6"	Fits for BC-size platform	
30676775	AISI 316 stainless steel platter, thickness 2.0mm, 600 x 800 mm /23.6" x 31.5"	Fits for CC-size platform	
30676776	AISI 316 stainless steel platter, thickness 2.5mm, 600 x 800 mm /23.6" x 31.5"	Fits for CC-size platform	

Explore Our Service Solutions

Tailored to Fit Your Equipment Needs

METTLER TOLEDO Service delivers resources to enhance your efficiency, performance and productivity by providing service packages that fit your operational needs, maximize your equipment lifetime, and protect your weighing solution scale investment.

► www.mt.com/IND-Service

Start with professional installation



Installation services include support for your unique production situation:

- Professional IQ/OQ/PQ/MQ documentation
- Initial calibration and confirmation of fit-for-purpose
- Hazardous area installations

Extend your warranty coverage



Add two years of preventive maintenance and repair coverage to protect your indicator or full system purchase and achieve maximum productivity and budget control.

Maintain accuracy over time



Receive professional guidance (GWP Verification™), including a routine testing plan that specifies four key factors to maximize your efficiency and ensure quality:

- Tests to perform
- Weights to use
- Testing frequency
- Tolerances to apply

Schedule maintenance



Full preventative maintenance plans offer inspection, functional testing, and proactive replacement of worn parts.

Health inspections offer a full assessment of current condition with professional maintenance recommendations.

Calibrate for quality and compliance

GWP®

Professional Accuracy Calibration Certificate (ACC) determines measurement uncertainty in use over the entire weighing range. Corresponding annexes give a clear pass/fail statement for specific tolerances applied, such as fit-for-purpose (GWP®), OIML R76, NTEP HB44, or further regulations.

www.mt.com/PBA436

For more information

METTLER TOLEDO Group

Industrial Division

Local contact: www.mt.com/contacts



Subject to technical changes

©11/2021 METTLER TOLEDO. All rights reserved

Document No. 30536854 A

MarCom Industrial